



User Manual

SAJ Single-phase Hybrid Solar Inverter

H1 Series



www.saj-electric.com

Content

Chapter 1 Safety Precautions	- 3 -
1.1 Scope of Application	- 3 -
1.2 Safety Instructions	- 3 -
1.3 Target Group	- 4 -
Chapter 2 Preparation	- 4 -
2.1 Intended Use	- 4 -
2.2 Safety Instructions	- 4 -
2.3 Explanations of Symbols	- 6 -
Chapter 3 Product Information	- 7 -
3.1 Application Scope of Products	- 7 -
3.2 Overview and Dimensions of Products	- 7 -
3.3 Datasheet	- 8 -
Chapter 4 Instructions for Installation	- 14 -
4.1 Safety Instructions	- 14 -
4.2 Pre-installation Check	- 14 -
4.3 The Determination of the Installation Method and Position	- 15 -
4.4 Mounting Procedure	- 16 -
Chapter 5 Electrical Connection	- 19 -
5.1 Safety Instruction for Hot-line Job	- 19 -
5.2 Specifications for Electrical Interface	- 20 -
5.3 AC Grid Wire and Backup Output Connection	- 21 -
5.4 PV Connection	- 23 -
5.5 Battery Connection	- 25 -
5.6 Earth Fault Alarm	- 27 -
5.7 Communication Connection	- 28 -

5.8 Connection Diagram	- 33 -
5.9 Ground Connection	- 34 -
5.10 External AC Circuit Breaker and Residual Current Device	- 34 -
Chapter 6 Debugging Instructions	- 35 -
6.1 Introduction of Human-computer Interface	- 35 -
6.2 First Run Setup	- 36 -
6.3 Shut Down Inverter	- 59 -
6.4 Monitoring Operation and Battery manage system	- 59 -
Chapter 7 Fault Code and Troubleshooting	- 60 -
Chapter 8 Recycling and Disposal	- 63 -
Chapter 9 Contact SAJ	- 64 -
Warranty Card	- 65 -

Chapter 1 Safety Precautions

1.1 Scope of Application

This User Manual describes instructions and detailed procedures for installing, operating, maintaining, and troubleshooting of the following SAJ hybrid solar inverters:

H1-3K-S2, H1-3.6K-S2, H1-4K-S2, H1-4.6K-LS2, H1-4.6K-S2, H1-5K-S2,
H1-5K-LS2, H1-6K-LS2, H1-6K-S2

Please read the user manual carefully before any installation, operation and maintenance and follow the instruction during installation and operation. Please keep this manual all time available in case of emergency.

1.2 Safety Instructions



DANGER

· DANGER indicates a hazardous situation, which, if not avoided, will result in death or serious injury.



WARNING

· WARNING indicates a hazardous situation, which, if not avoided, can result in death or serious injury or moderate injury.



CAUTION

· CAUTION indicates a hazardous condition, which, if not avoided, can result in minor or moderate injury.



NOTICE

· NOTICE indicates a situation that can result in potential damage, if not avoided.

1.3 Target Group

Only qualified electricians who have read and fully understood all safety regulations contained in this manual can install, maintain and repair the inverter. Operators must be aware of the high-voltage device.

Chapter 2 Preparation

2.1 Intended Use

The product is not suitable for supplying power to life-support medical equipment.

Loads connected to the product must have a CE identification label.

The maximum DC input voltage of the product must not be exceeded. Turn off DC switch before any installation and operation.

2.2 Safety Instructions



DANGER

- There is possibility of dying due to electrical shock and high voltage.
- Do not touch the operating component of the inverter; it might result in burning or death.
- To prevent risk of electric shock during installation and maintenance, please make sure that all AC and DC terminals are plugged out.
- Do not touch the surface of the inverter while the housing is wet, otherwise, it might cause electrical shock.
- Do not stay close to the inverter while there are severe weather conditions including storm, lightning, etc.
- Before opening the housing, the SAJ inverter must be disconnected from the grid and PV generator; you must wait for at least five minutes to let the energy storage capacitors completely discharged after disconnecting from power source.

 **WARNING**

The installation, service, recycling and disposal of the inverters must be performed by qualified personnel only in compliance with national and local standards and regulations.

Any unauthorized actions including modification of product functionality of any form may cause lethal hazard to the operator, third parties, the units or their property. SAJ is not responsible for the loss and these warranty claims.

The SAJ inverter must only be operated with PV generator. Do not connect any other source of energy to the SAJ inverter.

Be sure that the PV generator and inverter are well grounded in order to protect properties and persons.

 **CAUTION**

The inverter will become hot during operation. Please do not touch the heat sink or peripheral surface during or shortly after operation.









Risk of damage due to improper modifications.

 **NOTICE**

Public utility only.

The inverter is designed to feed AC power directly to the public utility power grid; do not connect AC output of the inverter to any private AC equipment.

2.3 Explanations of Symbols

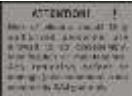
Symbol	Description
	Dangerous electrical voltage This device is directly connected to public grid, thus all work to the inverter shall only be carried out by qualified personnel.
	Danger to life due to high electrical voltage! There might be residual currents in inverter because of large capacitors. Wait 5 MINUTES before you remove the front lid.
	Notice, danger! This is directly connected with electricity generators and public grid.
	Danger of hot surface The components inside the inverter will release a lot of heat during operation. Do not touch metal plate housing during operating.
	An error has occurred Please go to Chapter 9 “Troubleshooting” to remedy the error.
	This device SHALL NOT be disposed of in residential waste Please go to Chapter 8 “Recycling and Disposal” for proper treatments.
	Without Transformer This inverter does not use transformer for the isolation function.
	CE Mark With CE mark & the inverter fulfills the basic requirements of the Guideline Governing Low-Voltage and Electro-magnetic Compatibility.
	RCM Mark Equipment meets safety and other requirements as required by electrical safety laws/regulations in Australian and New Zealand.
	No unauthorized perforations or modifications Any unauthorized perforations or modifications are strictly forbidden, if any defect or damage (device/person) occurred, SAJ shall not take any responsibility for it.

Chapter 3 Product Information

3.1 Application Scope of Products

H1 series products are hybrid solar inverters without transformers, and the inverters are important components of energy storage systems.

The H1 inverters converts the DC generated by solar panels into AC which is in accordance with the requirements of public grid and send the AC into the grid, reduce the load pressure of the grid.

When the grid failure, provide AC source to supply important loads, achieve uninterrupted power supply function.

3.2 Overview and Dimensions of Products

The dimensions of H1 series products are shown in Figure 3.1.

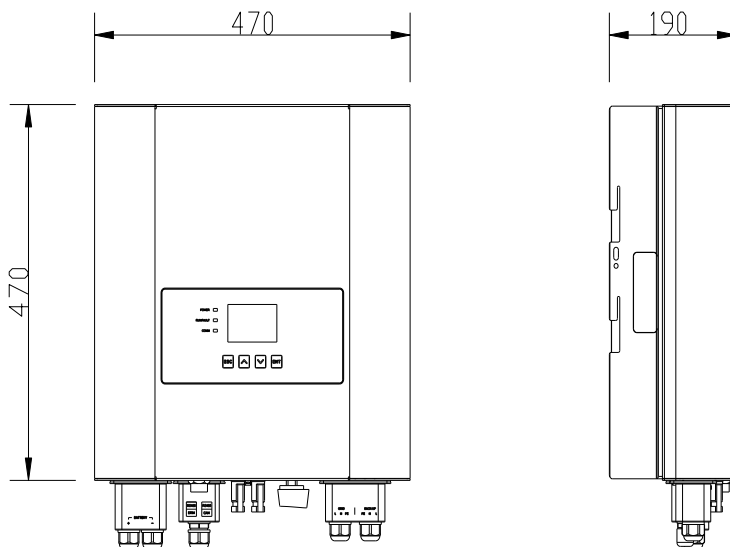

Figure 3.1 Dimensions of H1 series Product

3.3 Datasheet

MODEL	H1-3K-S2	H1-3.6K-S2	H1-4K-S2	H1-4.6K-LS2	H1-4.6K-S2
Input(DC)					
Max.PV Array Power[Wp]@STC	4500	5400	6000	6900	6900
Max. DC Voltage [V]	600				
MPPT Voltage Range [V]	90~550				
Nominal DC Voltage[V]	360				
Start Voltage [V]	120				
Min. DC Voltage [V]	80				
Max. DC Input Current[A]	12.5 / 12.5				
Max. DC Short Current[A]	15 / 15				
Number of MPPT	2				
DC Switch	Integrated				
Battery Data					
Battery Type	Lithium battery				
Battery Input Voltage /Range of Voltage [V]	48 / 42~58.4				
Max./Rated Charge Current [A]	60/60				100 / 100
Charging Mode Control	3-stages				
Grid Data [On grid Mode]					
Rated Output Power[W]	3000	3680	4000	4600	4600
Max. Output Power [VA]	3000	3680	4000	4600	4600
Rated Output Current [A]	13.1	16.0	17.4	20.0	20.0
Max. Output Current [A]	13.6	16.7	18.2	20.9	20.9
Rated Grid voltage /Range [V]	220V, 230V, 240V / 180V~280V				
Rated Grid Frequency / Range [Hz]	50 / 60 ±5				
Power Factor [cos φ]	0.8 leading~0.8 lagging				
Total Harmonic Distortion [THDi]	<3%				
Feed-in	L+N+PE				
AC Output Data [Back-up Mode]					

Max. Output Power [VA]	3000	4600
Output Voltage [V]	220/230/240	
Output Frequency [Hz]	50/60	
Total Harmonic Distortion of Voltage	<3%	
Peak Output Apparent Power [VA]	3600, 10sec	5500, 10sec
Efficiency		
Max. Efficiency	97.6%	
Euro Efficiency	97.0%	
Max. Battery to Load Efficiency	94.6%	
Protection		
AC Short Circuit Protection	Integrated	
Overload Protection	Integrated	
DC Overvoltage/ Undervoltage Protection	Integrated	
AC Overvoltage/ Undervoltage Protection	Integrated	
AC Overfrequency/ Underfrequency	Integrated	
Over Thermal Protection	Integrated	
Anti-islanding protection	Integrated	
Peak-to-trough Period Setting	Integrated	
Interface		
PV Connection Type	MC4	
Battery Connection Type	Terminal Block	
AC Connection Type	Terminal Block	
Display	LCD	
Communication port	RS485*2& RS232&DRM*2 (Integrated)	
Communication Mode	Wi-Fi/GPRS/Ethernet(Optional)	
General Data		
Topology	Transformerless	
Ingress Protection	IP65	
Operating Temperature Range	-25~+60°C [45~60°C with derating]	

Ambient Humidity	0~100% No Condensing
Altitude	4000m(>3000m power derating)
Noise[dBA]	<29
Cooling method	Natural Convection
Dimensions[H*W*D][m m]	470*470*190
Weight[kg]	23
Standard Warranty[year]	5
Applicable Standard	IEC62109-1/2,IEC61000-6-1/2/3/4,EN50438,EN50549,C10/C11,IEC62116 ,IEC61727,RD1699,UNE 206006,UNE 206007,CEI 0-21,AS4777.2, CQC NB/T 32004,VDE-AR-N 4105

MODEL	H1-5K-LS2	H1-5K-S2	H1-6K-LS2	H1-6K-S2
Input(DC)				
Max.PV Array Power[Wp]@STC	7500		9000	
Max. DC Voltage [V]	600			
MPPT Voltage Range [V]	90~550			
Nominal DC Voltage[V]	360			
Start Voltage [V]	120			
Min. DC Voltage [V]	80			
Max. DC Input Current[A]	12.5 / 12.5			
Max. DC Short Current[A]	15 / 15			
Number of MPPT	2			
DC Switch	Integrated			
Battery Data				
Battery Type	Lithium battery			
Battery Input Voltage /Range of Voltage [V]	48 / 42~58.4			
Max./Rated Charge Current [A]	60/60	100 / 100	60/60	100 / 100
Charging Mode Control	3-stages			
Grid Data [On grid Mode]				
Rated Output Power[W]	5000*1		6000	
Max. Output Power [VA]	5000		6000	
Rated Output Current [A]	21.8*2		26.1	
Max. Output Current [A]	22.7		27.3	
Rated Grid voltage /Range [V]	220V, 230V, 240V / 180V~280V			
Rated Grid Frequency / Range [Hz]	50 / 60 ±5			
Power Factor [cos φ]	0.8 leading~0.8 lagging			
Total Harmonic Distortion [THDi]	<3%			
Feed-in	L+N+PE			
AC Output Data [Back-up Mode]				
Max. Output Power [VA]	3000	5000	3000	5000
Output Voltage [V]	220/230/240			

Output Frequency [Hz]	50/60			
Total Harmonic Distortion of Voltage	<3%			
Peak Output Apparent Power [VA]	3600, 10sec	6000, 10sec	3600, 10sec	6000, 10sec
Efficiency				
Max. Efficiency	97.6%			
Euro Efficiency	97.0%			
Max. Battery to Load Efficiency	94.6%			
Protection				
AC Short Circuit Protection	Integrated			
Overload Protection	Integrated			
DC Overvoltage/ Undervoltage Protection	Integrated			
AC Overvoltage/ Undervoltage Protection	Integrated			
AC Overfrequency/ Underfrequency	Integrated			
Over Thermal Protection	Integrated			
Anti-islanding protection	Integrated			
Peak-to-trough Period Setting	Integrated			
Interface				
PV Connection Type	MC4			
Battery Connection Type	Terminal Block			
AC Connection Type	Terminal Block			
Display	LCD			
Communication port	RS485*2& RS232&DRM*2 (Integrated)			
Communication Mode	Wi-Fi/GPRS/Ethernet(Optional)			
General Data				
Topology	Transformerless			
Ingress Protection	IP65			
Operating Temperature Range	-25~+60°C [45~60°C with derating]			
Ambient Humidity	0~100% No Condensing			
Altitude	4000m(>3000m power derating)			

Noise[dBA]	<29
Cooling method	Natural Convection
Dimensions[H*W*D][mm]	470*470*190
Weight[kg]	23
Standard Warranty[year]	5
Applicable Standard	IEC62109-1/2,IEC61000-6-1/2/3/4,EN50438,EN50549,C10/C11,IEC62116,IEC61727,RD1699,UNE 206006,UNE 206007,CEI 0-21,AS4777.2, CQC NB/T 32004, VDE-AR-N 4105

Note: *1 For AS/NZS 4777.2 Rated Output Power is 4999VA.

***2 For AS/NZS 4777.2 Rated Output Current is 21.7A.**

Chapter 4 Instructions for Installation

4.1 Safety Instructions



DANGER

- Dangerous to life due to potential fire or electricity shock.
- Do not install the inverter near any inflammable or explosive items.
- This inverter will be directly connected with HIGH VOLTAGE power generation device; the installation must be performed by qualified personnel only in compliance with national and local standards and regulations.



NOTICE

- This equipment meets the pollution degree II.
- Inappropriate or the harmonized installation environment may jeopardize the life span of the inverter.
- Installation directly exposed under intensive sunlight is not recommended.
- The installation site must be well ventilated.

4.2 Pre-installation Check

4.2.1 Check the Package

Although SAJ's inverters have surpassed stringent testing and are checked before they leave the factory, it is uncertain that the inverters may suffer damages during transportation. Please check the package for any obvious signs of damage, and if such evidence is present, do not open the package and contact your dealer as soon as possible

4.2.2 Check the Assembly Parts

Please refer to the Packing List inside the package container.

4.3 The Determination of the Installation Method and Position

4.3.1 Mounting Method

The equipment employs natural convection cooling, and it can be installed indoor or outdoor.

Do not expose the inverter to direct solar irradiation as this could cause power derating due to overheating.

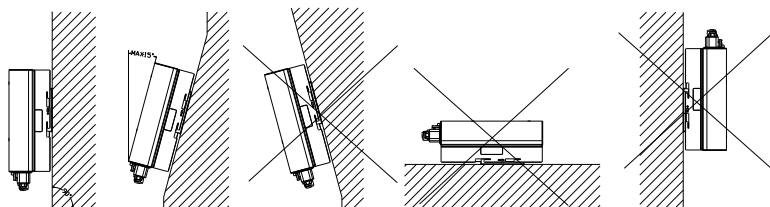

Figure 4.1 Mounting Method

(2) Mount vertically or tilted backwards by max. 15° . Never install the inverter tilted forwards, sideways, horizontally or upside down.

(3) Install the inverter at eye level for convenience when checking the LCD display and possible maintenance activities.

(4) When mounting the inverter, please consider the solidness of wall for inverter, including accessories. Please ensure the Rear Panel mount tightly.

To make sure the installation spot is suitably ventilated, if multiple SAJ hybrid solar inverters are installed same area.

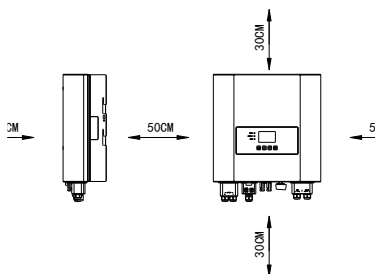

Figure 4.2 Minimum Clearance

4.4 Mounting Procedure

4.4.1 Mark the Positions of the Drill Holes of the Rear Panel

The mounting position should be marked as shown in Figure 4.3.

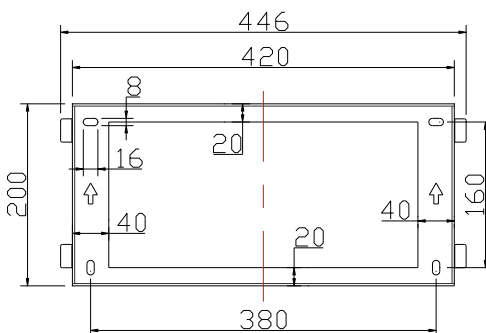

Figure 4.3 Dimensions of rear panel of H1 inverter

4.4.2 Drill Holes and Place the Expansion Tubes

Following the given guides, drill 4 holes in the wall (in conformity with position marked in Figure 4.4, and then place expansion tubes in the holes using a rubber mallet.

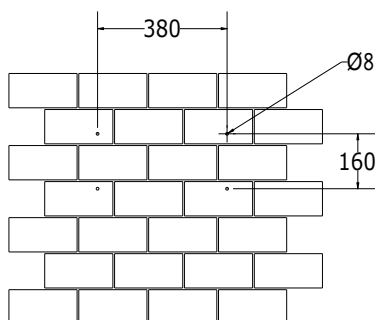

Figure 4.4 Drill holes dimensions of H1 inverter

4.4.3 Mount the Screws and the Rear Panel

The panels should be mounted in the mounting position by screws as shown in Figure 4.5.

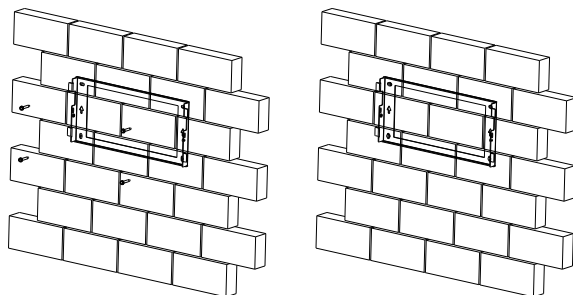

Figure 4.5 Mount the Rear Panel of H1 inverter

4.4.4 Mount the Inverter

Carefully mount the inverter to the rear panel as shown in Figure 4.6. Make sure that the rear part of the equipment is closely mounted to the rear panel.

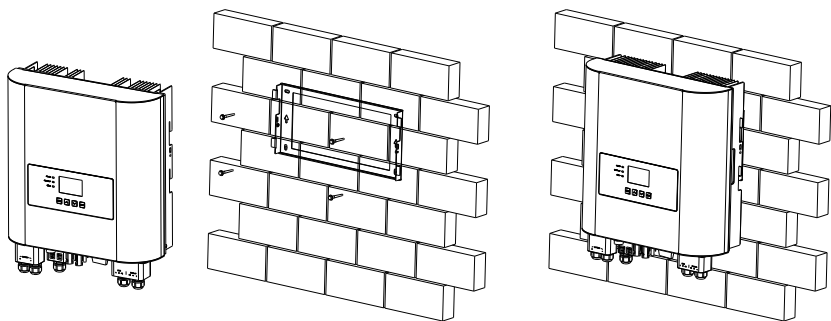

Figure 4.6 Mount H1 inverter

Chapter 5 Electrical Connection

5.1 Safety Instruction for Hot-line Job

Electrical connection must only be operated on by professional technicians. Please keep in mind that the inverter is a bi-power supply equipment. Before connection, necessary protective equipment must be employed by technicians including insulating gloves, insulating shoes and safety helmet.



DANGER

- Dangerous to life due to potential fire or electricity shock.
- When power-on, the equipment should in conformity with national rules and regulations.
- The direct connection between the inverter and high voltage power systems must be operated by qualified technicians in accordance with local and national power grid standards and regulations.



WARNING

- When the photovoltaic array is exposed to light, it supplies a DC voltage to the inverter.



NOTICE

Electrical connection should in conformity with proper stipulations, such as stipulations for cross-sectional area of conductors, fuse and ground protection.

The overvoltage category on DC input port is II, on AC output port is III.

5.2 Specifications for Electrical Interface

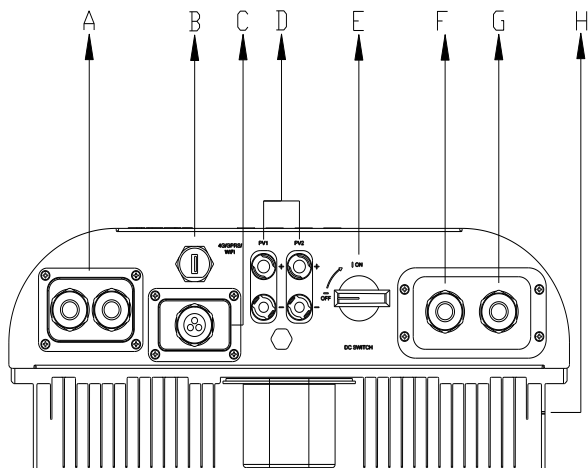

Figure 5.1 Electrical Interface of H1 inverter

Code	Name
A	Battery Input
B	RS232 /4G/GPRS/Wi-Fi Port
C	RS485 & DRM Port & CAN
D	DC Input
E	DC Switch
F	On-Grid Terminal
G	Backup Plug Terminal
H	Ground Connection

Table 5.1 Specifications for Interface

5.3 AC Grid Wire and Backup Output Connection

Caution: For safety operation and regulation compliance, it is requested to install a breaker (63A) between grid and inverter.

Cable Cross-sectional area (mm ²)		External diameter (mm)	
Range	Recommend	Range	Recommend
2.5~6.0	4.0	8~14	14

Table 5.2 Recommended Specifications of AC Cables

If the grid-connection distance is too far, please amplify diameter selection of the AC cable as per the actual condition.

5.3.1 Open the waterproof cover, feed the AC cable through the AC waterproof hole.

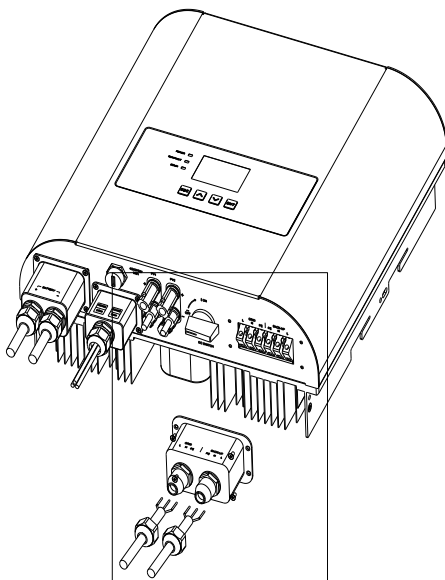

Figure 5.2 Thread the cables

5.3.2 Connect the cables according to connection marks of L, N and PE.

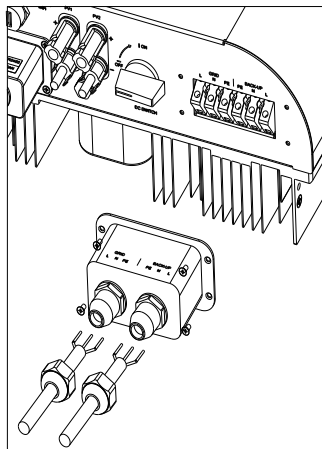

Figure 5.3 Connect the Cables

5.3.3 Secure all parts of the grid and backup connector tightly.

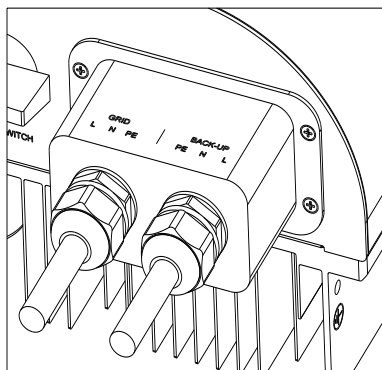

Figure 5.4 Screw the Connector

5.3.4 During off-network operation time, null line at the BACK-UP end will remain to be connected with the null line at the power grid end inside the machine. (Only applicable to market in Australia)

5.4 PV Connection

Cable Cross-sectional area (mm ²)		External diameter (mm)	
Range	Recommend	Range	Recommend
4.0~6.0	4.0	4.2~5.3	5.3

Table5.3 Recommended Specifications of DC Cables

DC connector is made up of the positive connector and the negative connector

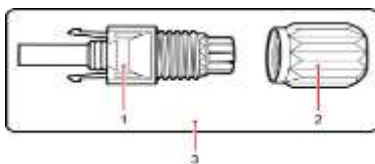

1. Insulated Enclosure

2. Lock Screw

3. Positive Connector

Figure 5.5 Positive Connector

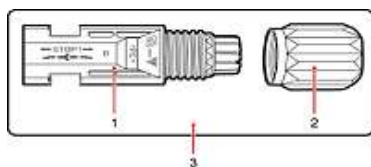

1. Insulated Enclosure

2. Lock Screw

3. Negative Connector

Figure 5.6 Negative Connector



NOTICE

· Please place the connector separately after unpacking in order to avoid confusion for connection of cables.

· Please connect the positive connector to the positive side of the solar panels, and connect the negative connector to the negative side of the solar side. Be sure to connect them in right position.

Connecting Procedures:

- (1) Tighten the lock screws on positive and negative connector.
- (2) Use specified strip tool to strip the insulated enclosure of the positive and negative cables with appropriate length.

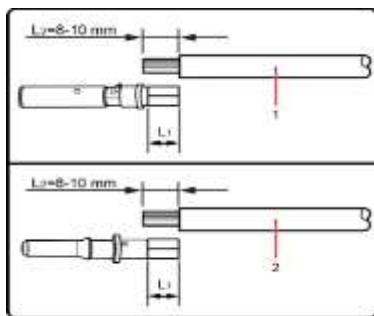

1. Positive Cable

2. Negative Cable

Figure 5.7 Connecting Cables

- (3) Feed the positive and negative cables into corresponding lock screws.
- (4) Put the metal positive and negative terminals into positive cable and negative cable whose insulated enclosure has been stripped off, and crimp them tightly with a wire crimper. Make sure that the withdrawal force of the pressed cable is larger than 400N.
- (5) Plug in the pressed positive and negative cables into relevant insulated enclosure, a “click” should be heard or felt when the contact cable assembly is seated correctly.
- (6) Fasten the lock screws on positive and negative connectors into corresponding insulated enclosure and make them tight.
- (7) Connect the positive and negative connectors into positive and negative DC input terminals of the inverter, a “click” should be heard or felt when the contact cable assembly is seated correctly.

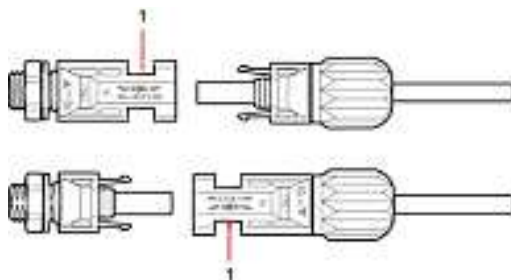

1. Connection Port

Figure 5.8 Connect the Inverter

**NOTICE**

· Before insert the connector into DC input terminal of the inverter, please make sure that the DC switch of the inverter is OFF.

Please use the original H4 terminal to install.

5.5 Battery Connection

Caution: For safety operation and regulation compliance, it's requested to install a breaker ($\geq 125A$) between battery and inverter.

Cable Cross-sectional area (mm ²)		External diameter (mm)	
Range	Recommend	Range	Recommend
16~25	16	8~14	14

Table 5.4 Recommended Specifications of DC Cables

5.5.1 Open the waterproof cover, then feed the battery cable through the AC waterproof hole.

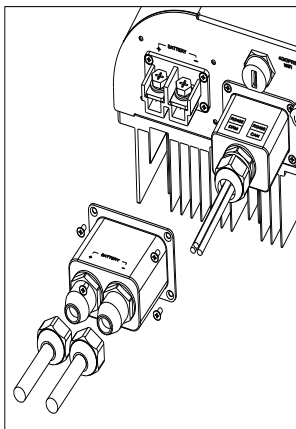

Figure5.9 Open the Waterproof Cover

5.5.2 Strip the insulation skin of DC cable, the core is exposed to 10mm, and use a special tool to press the Battery Terminal.

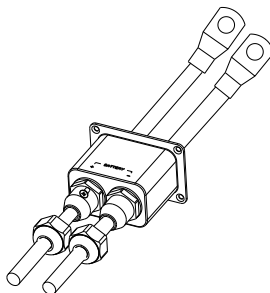

Figure 5.10 Battery Terminal

5.5.3 Fixing the battery cable on the battery's copper terminal by positive and negative in order.

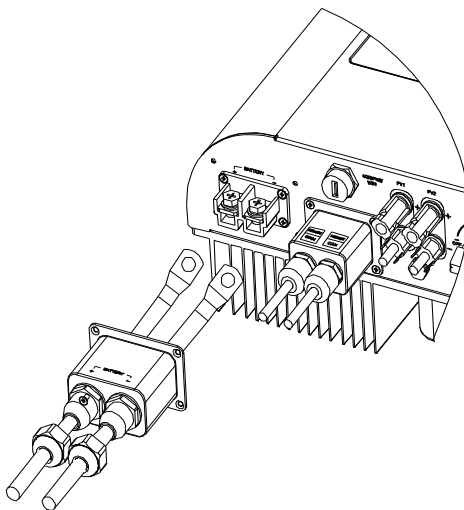

Figure 5.11 Connect the Battery Cable

5.6 Earth Fault Alarm

This inverter complies with IEC 62109-2 clause 13.9 for earth fault alarm monitoring. If an Earth Fault Alarm occurs, the second LED indicator will be lit up and error code <06 ISO Err> will be displayed on the screen of inverter until the error being solved and inverter functioning properly.

5.7 Communication Connection

5.7.1 Serial Port Definition

H1 series hybrid inverter has a RS232 communication port integrated.

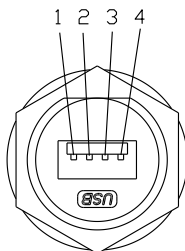

Figure 5.12 9-Pin serial port

Pin Number	Description	Effect
1	+7V	Power supply
2	RS-232 TX	Send data
3	RS-232 RX	Receive data
4	GND	Ground wire

Table 5.5 9-Pin serial port introduction

USB interface with Wi-Fi module, please reference Wi-Fi user manual.

5.7.2 RJ45 Pin Port Definition.

Left		RS485	Right	
1	NC		1	NC
2	NC	2	NC	
3	NC	3	NC	
4	NC	4	NC	
5	NC	5	NC	
6	NC	6	NC	
7	RS485-A+	7	RS485-A+	
8	RS485-B-	8	RS485-B-	

Left			Right	
1	DRM 1/5		1	NC
2	DRM 2/6		2	NC
3	DRM 3/7		3	NC
4	DRM 4/8		4	CANH
5	RefGen		5	CANL
6	Com/DRM 0		6	NC
7	V+		7	NC
8	V-		8	NC
				

Table 5.6 RJ45 pin port definition



Figure 5.13 Interface definition

5.7.3 Open the waterproof cover, pass the prepared communication cable through each component, insert corresponding communication port, then tighten the screws.

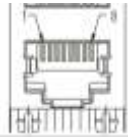
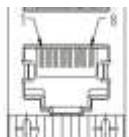
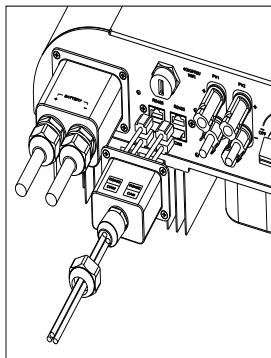

Figure 5.14 Connection of communication cable

5.7.4 Smart Meter Connection

Notice: The hybrid inverter is with export limitation function, which can be realized by connecting SAJ recommended smart meter to the hybrid energy storage system. Users can contact SAJ for further details for the smart meters. If users have no intention to set the export limitation function, please ignore chapter 5.7.4.

If users have purchased the smart meter that recommended by SAJ, before setting the export limitation function, users shall connect the meter to the system with procedures below:

- (1) Power cable connection: Connect Live to terminal 1 of the Meter to enter and exit from terminal 3. Connect Neutral to terminal 2 of the Meter to enter and exit from terminal 4.
- (2) Connect meter to Hybrid Inverter: Wire "RS485-A+" of inverter to terminal 24 of the Meter, then wire "RS485-B-" of inverter to terminal 25 of the Meter.

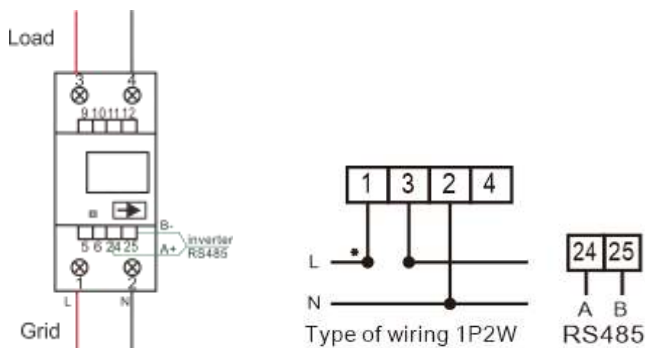

Figure 5.15 Meter wiring diagram

(3) Fixing Meter (DIN 35mm mounting)

There are buckles at the bottom of the meter. Buckle it on the grooves matched in size and fix it stably.

(4) Power on the meter and check if the meter is running.

(5) Confirm communication address of meter and hybrid inverter:

For both meter and hybrid inverter, the default communication address is 1. If the communication addresses are different, users can set the communication address value of hybrid inverter to the same value as meter's.

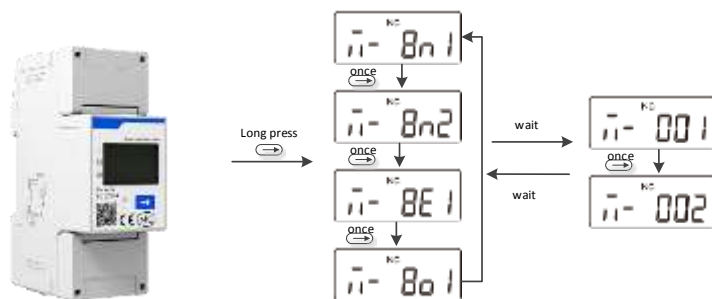

Figure 5.16 Communication address of meter

(6) After settings, users can move to set the Export Limitation Setup on the

hybrid inverter.

Select the “Setting” in menu, press ENT to the second menu, then select “Mode Setting”, press ENT to enter the interface of choosing Export Limitation Setup, as shown below

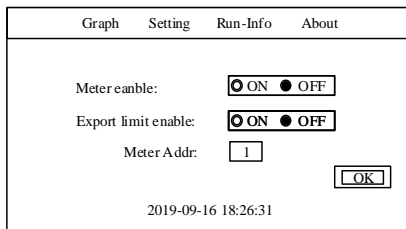

Figure 5.17 Mode Setting

Note: Meter is not waterproof or dust-proof, it is recommended to install it in the distribution box. If the current value showed in the meter is a negative value, the export limitation is working.

5.8 Connection Diagram

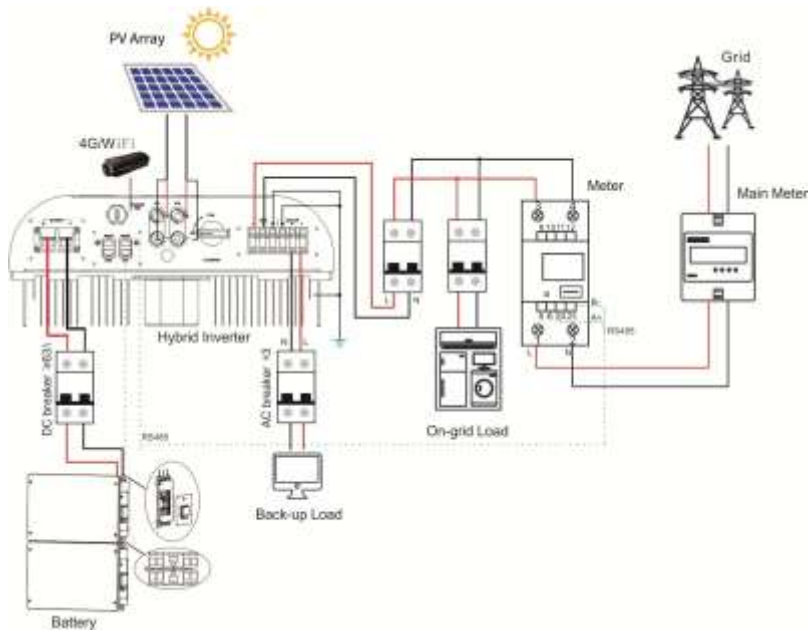
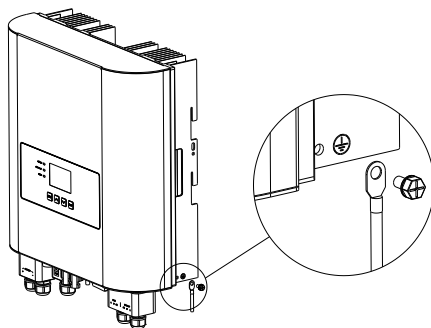

Figure 5.18 H1 Connection diagram

5.9 Ground Connection

After penetrating the external hex head screw through OT terminal of the grounding line, screw in the grounding port of enclosure of the inverter in clockwise direction and make sure it is screwed up tightly.



5.19 Inverter ground protection

5.10 External AC Circuit Breaker and Residual Current Device

Please install a circuit breaker to ensure the inverter is able to disconnect from grid safely. The inverter is integrated with a RCMU, however, an external RCD is needed to protect the system from tripping, either type A or type B RCD are compatible with the inverter.

The integrated leakage current detector of inverter is able to detect the real time external current leakage. When a leakage current detected exceeds the limitation, the inverter will be disconnected from grid quickly, if an external residual current device is connected, the action current should be 30mA or higher.

Chapter 6 Debugging Instructions

6.1 Introduction of Human-computer Interface

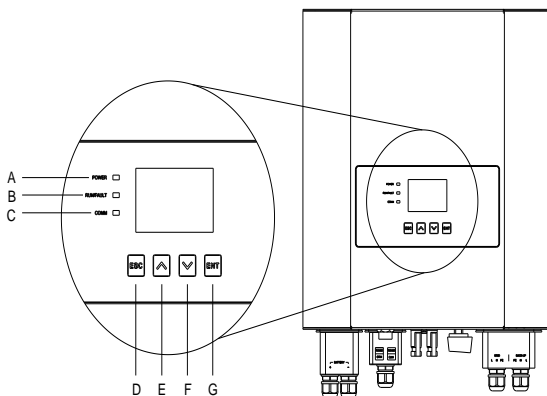

Figure 6.1 Human-computer Interface

LED indicator	Function	
A	Power status	On: Green LED on Off: LED off
B	Run/ fault status	Inverter running properly : Yellow LED on

		Inverter running faultily: Red LED on
C	Communication status	When a Wi-Fi/ 4G module is connected or inverter is upgrading: Yellow and blue light flashing alternatively

Table 6.1 Instructions of the Interface

Button	Function	
E ▲	A step up / left or increasing the setting value	
F ▼	A step down / right or decreasing the setting value	
D (ESC)	Press time shorter than 2 seconds	Return to main menu or canceling the setting
	Press time longer than 2 seconds	Cut off output to load
G (ENT)	Press time shorter than 2 seconds	Enter the sub-menu or confirming a selection
	Press time longer than 2 seconds	Turn on output to load

Table 6.2 Instructions for buttons

6.2 First Run Setup

6.2.1 Start Up Inverter

The H1 inverter can be start up by the following procedure:

1. Turn on the external AC switch (grid side)
2. Turn on the DC switch on the inverter
3. Turn on the battery switch between inverter and battery

6.2.2 System Time Setting

When the inverter begins to run for the first time, please configure the time of system, and the inverter LCD will display as below:

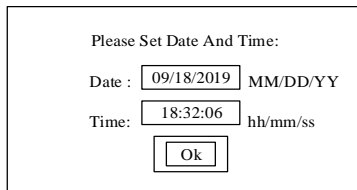

Figure 6.2 System time setting

When the cursor selected the edit box, press ENT to edit status, set the target value by pressing ▼ or ▲. If press time longer than 2 seconds, the value will decrease or increase quickly. With the edit status, switching different value setting by pressing ENT. Drop out of edit status by pressing ESC. With the edit status, switch different edit box or button by pressing ▼ or ▲.

Operating and interface description:

With user selected the editable box of Date, edit the system date by pressing ENT, and switch to the setting of M/D/Y, set the target value by pressing ▼ or ▲, drop out of edit status by pressing ESC. Same operation as edit system time.

Note: With the cursor selected the editable box, a dialog box will appear to request setting system time while press ESC. This dialog box prompts to remind user not to skip the debugging at the first time running. LCD will display as below:

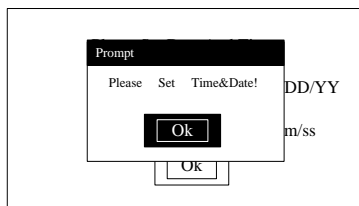

Figure 6.3 System time setting (Prompt by ESC)

6.2.2 Battery Data Setting

While inverter using at the first time, after setting system time, then set the battery data, LCD will display as below:

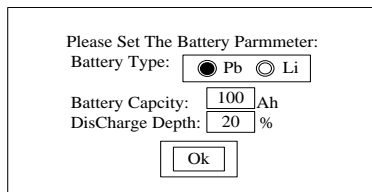

Figure 6.4 Battery setting

Operating and interface description:

With user selected the edit box of Battery Type, edit the battery species by pressing ENT, switch the selected object by pressing ▼ or ▲, drop out of edit status by pressing ESC; Selected the edit box of Battery Capacity, set the battery capacity, selected the edit box of Discharge, set the Battery discharge depth.

Note: With the cursor selected the edit box, a dialog box will appear to request setting system time while press ESC. This dialog box prompt user not to skip setting battery data.

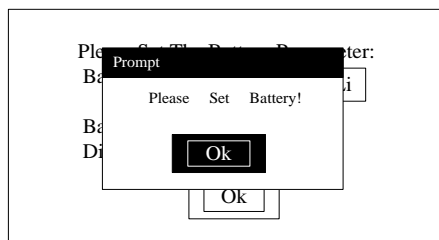

Figure 6.5 Battery setting (Prompt by pressing ESC)

6.2.3 Set the Country

When the inverter begins to run for the first time, please configure the country of usage, and the inverter LCD will display as below:

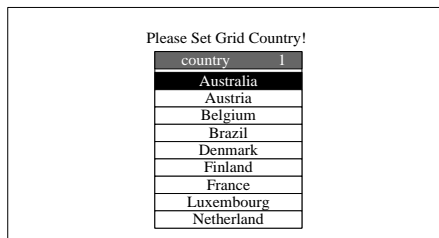

Figure 6.6 Country setting

Operating and interface description:

Users can press "▼" or "▲" to select the correct country and press "ENT" button to confirm the selection.

While a country contains several compliances, they will appear next to this country, as shown below:

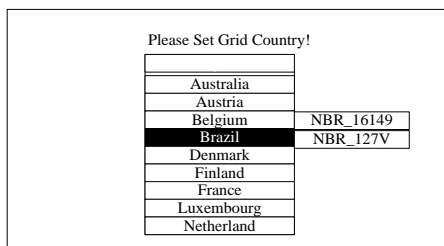

Figure 6.7 Country setting (Country with several compliances)

LCD will show countries to selected, users could press ▼ or ▲ to move cursor “>”, select correct country and press “ENT”.

If users cannot find out the corresponding country, please stop the setting and contact the after sales for confirmation.

Note: With the cursor selected the edit box, a dialog box will appear to request

setting system time while press ESC. This dialog box prompt user set country grid compliance, this step cannot be skipped.

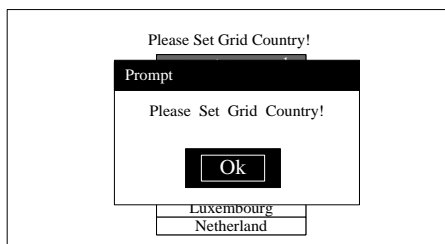

Figure 6.8 Grid compliance setting (Prompt by ESC)

6.2.4 Inverter System Main Interface

After the country has been set, system will reset and show main interface, as show below. (Standby mode).

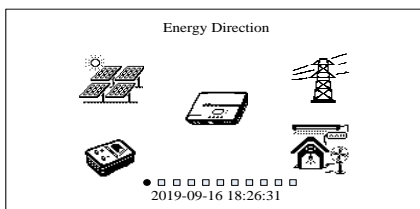

Figure 6.9 Main Interface

If system running normally, main screen will show the power flowing illustration, as show below.

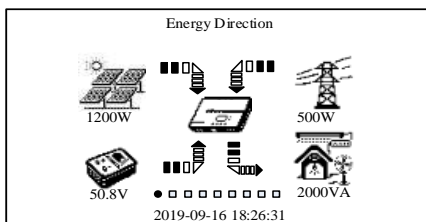

Figure 6.10 Power flow illustration (System running normally)

If system running in different states, power flow illustration will switch as states. For example, when in Off-grid state, cut off the Grid, the dynamic power flow arrow will disappear. When no PV power, the PV dynamic power flow arrow will disappear. When no load output, the load output dynamic power flow arrow will disappear.

In system main screen, user could press ▼ or ▲ to view chart.

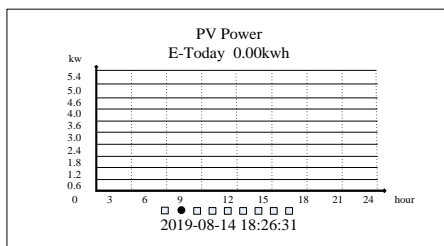

Figure 6.11 PV power and daily generation

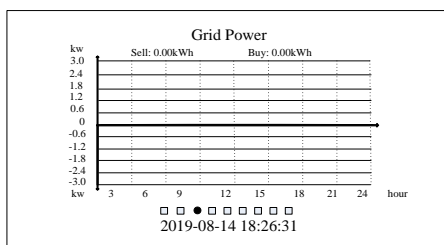

Figure 6.12 Power Trading of Grid and daily generation

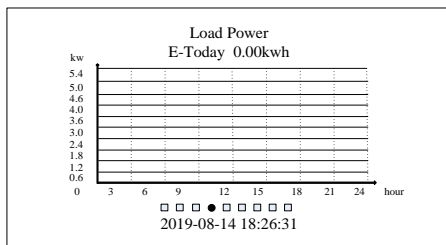

Figure 6.13 Load power and daily generation

As figures 6.11 shown, the figure shows the PV, loads or trading of Grid in all day long. E-Today represents the daily power generation.

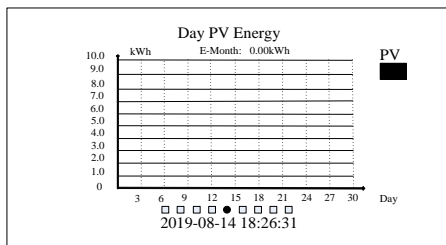

Figure 6.14 Daily generation in this month

In the figure 6.14, it shows the PV input in all days in this month.

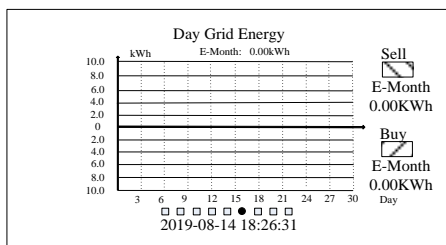

Figure 6.15 Daily sell to Grid in this month.

In the figure above, it shows the daily output in all days in this month.

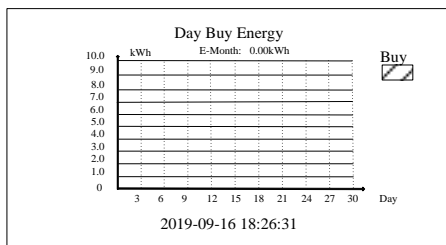

Figure 6.16 Daily buy from Grid in this month

In the figure above, it shows the daily input from Grid all days in this month.

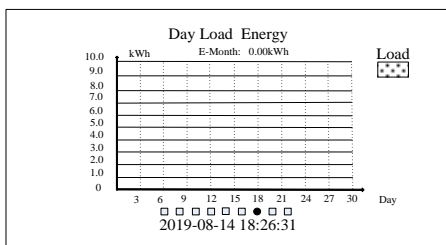

Figure 6.17 Daily load consumption in this month

In the figure above, it shows the daily output from load all days in this month.

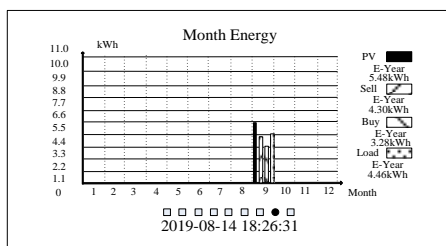

Figure 6.18 Monthly PV, trading with Grid, load consumption in this year

In the figure above, it shows monthly power of PV, Grid (Trading power), and load output. It also shows the accumulate PV, Grid, and load power in this year on the

right of figure.

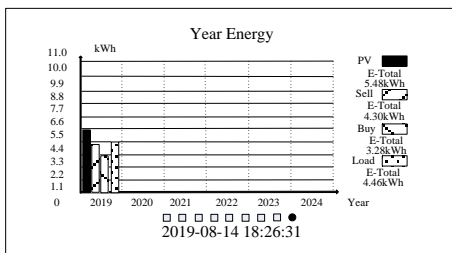

Figure 6.19 Totally PV, Trading power and load consumption

In the figure above, it shows the annual power of PV, Grid (trading power) and load output in recent 6 years. It also shows the final accumulated power of PV, Grid, and load power in this year on the right of figure.

With system interface status, user can back to system power flow main screen by pressing ESC button. If pressing ENT button, main screen will occur the drop-down menu, as show blow.

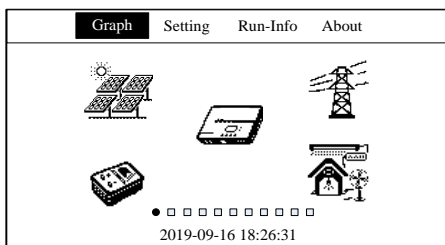

Figure 6.20 Drop-down menu

User could press ▼ or ▲ to selected the corresponding option

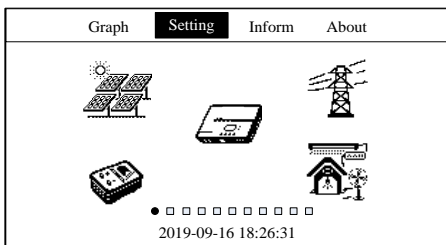

Figure 6.21 Switch menu option left/right

While the option has been selected, press ENT button to next interface. Figure below shows the main edit interface that enter the 'Graph':

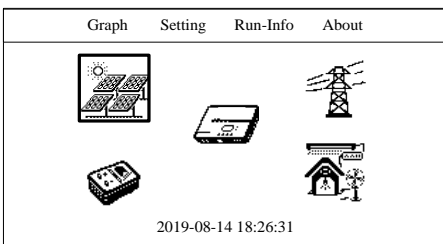

Figure 6.22 Main edit interface

If the menu option has the second menu interface, it will appear by press the ENT button. The figure below shows the second menu of "Setting":

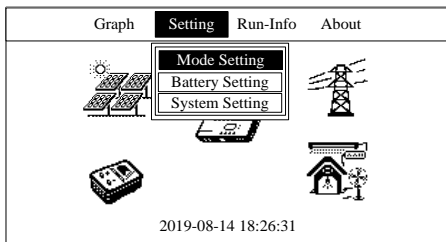

Figure 6.23 The second menu of "Setting"

The figure below shows the second menu of “Run-Info”:

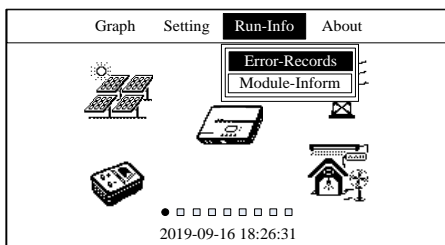

Figure 6.24 The second menu of “Run-Info”

The figure below shows the interface of “About” by pressing ENT.

Graph	Setting	Run-Info	About
Device	Type:	XXXX	
Device	SN Code:	32030G1547CN02000	
Device	PC Code:	SF05KMTL1CN6ED1000	
HMI	SW:	V2.001	
Master	Ctrl.SW:	V1.007	
Slaver	Ctrl.SW:	V1.007	
Grid	Country:	Australia	
Grid	Compliance:	AS4777	
2019-08-15 18:26:31			

Figure 6.25 The interface of “About”

The main edit interface, press ▼ or ▲ to select menu icon, as shown below:

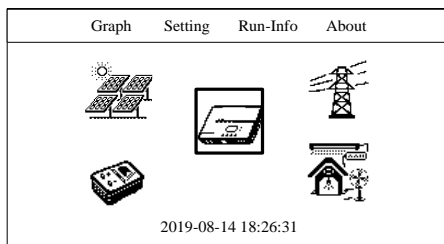

Figure 6.26 Menu icon selected

In the main edit interface, press ESC button to back menu option to selected status; press ENT button to enter the sub-interface of main menu icon. The figure below shows the PV parameter while selecting the PV panels:

Graph	Setting	Run-Info	About
	PV1 Voltage:	330.2V	
	PV1 Current:	2.00A	
	PV1 Power:	660.4W	
	PV2 Voltage:	330.2V	
	PV2 Current:	2.00A	
	PV2 Power:	660.4W	
2019-09-16 18:26:31			

Figure 6.27 PV parameter

In the main edit interface, by selecting inverter icon, press ENT button to show the parameter of inverter's running information:

Graph	Setting	Run-Info	About
	App Mode:	Smart Home Mode	
	Inverter State:	Standby State	
	Temperature:	36.5℃	
	BUS Voltage:	384.2V	
	AmbtempC:	36.5℃	
	Charge State:	Disable	
	DisCharge State:	Disable	
	OutPut State:	Disable	
	Sell Excess Energy:	Disable	
2019-09-16 18:26:31			

Figure 6.28 Information of inverter's running

In main edit interface, by selecting Grid icon, press ENT button to show the parameter of inverter's output information:

Graph	Setting	Run-Info	About
	Grid Voltage:	220.8V	
	Grid Current:	1.02A	
	Grid Power:	225W	
	Grid Frequency:	49.7Hz	
	Meter Power:	0W	
2019-09-16 18:26:31			

Figure 6.29 Information of inverter's output

In main edit interface, by selecting battery icon, press ENT button to show the parameter of inverter's battery information. (The figure below shows the Li-ion battery)

Graph	Setting	Run-Info	About
	Device Name:	PHANTOM-S	
	Trade Name:		
	Battery Type:	LiFePo4	
	Total Capacity:	100Ah	
	Capacity Percent:	100%	
	Pack Num:	2	
	Temperature:	34.0°C	
	Battery Voltage:	50.5V	
	Battery Current:	20.1A	
2019-09-16 18:26:31			

Figure 6.30 Information of Li-ion battery

Graph	Setting	Run-Info	About
	Battery Type:	Lead-acid Battery	
	Total Capacity:	100Ah	
	Battery Voltage:	50.5V	
	Battery Current:	1.01A	
	Battery Power:	51W	
2019-09-16 18:26:31			

Figure 6.31 Information of Lead-acid battery

In main edit interface, by selecting load icon, press ENT button to show the parameter of load's output information.

Graph	Setting	Run-Info	About
	Out-Voltage:	220.2V	
	Out-Curret:	1.00A	
	Out-power:	200W	
	Out-ApparentPower:	220VA	
	Out-Frequency:	49.9Hz	
2019-09-16 18:26:31			

Figure 6.32 Information of load's output

Selecte the “Run-Info” in menu, press ENT to the second menu, then select “Error Records”, press ENT to enter error and warning, as shown below:

Graph		Setting	Run-Info	About
No.	Date/Time	Error Code:	Information	
1	09/18/2016 20:17	29:Grid Loss		Warn
		34:Bat Volt.High		Err
		39:Bus Volt.High		Err
		48:CHG2 Curr		Err
100				
2019-08-14 18:26:31				

Figure 6.33 Error and warning

Select the “Setting” in menu, press ENT to the second menu, then select “Mode Setting”, press ENT to enter the interface of choosing running mode, as shown below:

Graph	Setting	Run-Info	About
	<input checked="" type="radio"/>	User Mode Setup	
	<input type="radio"/>	AC Charge Setup	
	<input type="radio"/>	Discharge Setup	
	<input type="radio"/>	Export Limitation Setup	
2019-08-14 18:26:31			

Figure 6.34 Parameter setting of Smart Home Mode

With this mode, press ▼ or ▲ to switch Sell Energy Setup, AC Charge Setup, AC DisCharge Setup. press ENT to the second menu, as shown below:

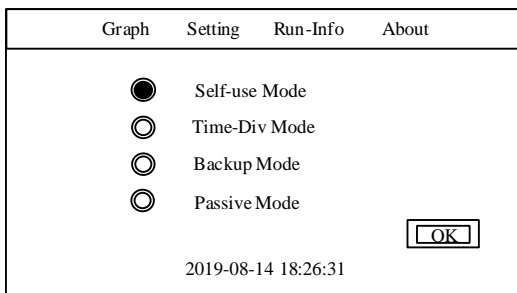

Figure 6.35 Sell Energy Setup

Self-use Mode: When the solar is sufficient, electricity generated by photovoltaic system will be supplied to load first, the surplus energy will be stored in battery, then the excess electricity will be exported to the grid. When the solar is insufficient, the battery will release electricity to supply load.

Time-Div Mode: Battery charging period and discharging period can be set, during charging period, battery can only be charged, while in discharging period, battery can only be discharged, the rest of the period, battery will behave as Self-use mode.

Backup Mode: Battery SOC setting value can be adjusted, when SOC is less than SOC setting value, battery can only be charged, until SOC is larger than SOC_H, the battery will be stopped charging; when SOC is larger than SOC setting value, battery will behave as Self-use mode.

Passive Mode: System will dispatch energy according to user instruction, which is used for passive charging or discharging of external equipment to request electricity.

To set up “AC Charge Setup” and “AC DisCharge Setup”, if not to add parameter, the default will show no parameter, as shown below:

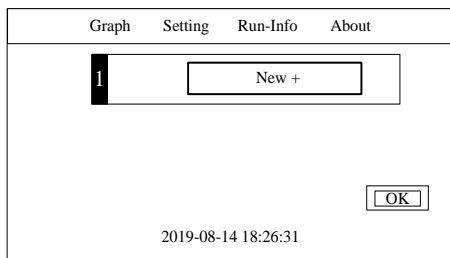

Figure 6.36 Add AC Charge/Discharge Setup

To set up AC Charge/Discharge parameter, in the interface of add “AC Charge/Discharge Setup”, press ▼or▲ to select different edit box, press ENT to enter edit status, press ESC to exit edit status. With the single parameter status selection, press ESC button to select current parameter, then edit these information by ▼or▲, as shown below.

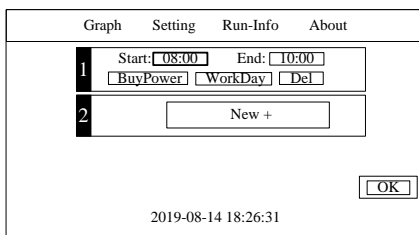

Figure 6.37 Edit the AC Charge/Discharge Setup parameter

In the single parameter selected records, select “Workday” to choose working date, press ENT to select or cancel, press ESC to return to previous interface, as shown below:

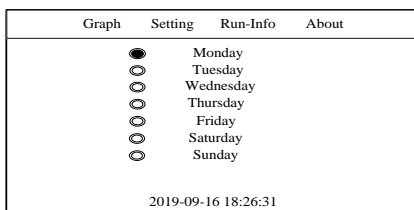

Figure 6.38 Select WorkDay's interface

Setting export limitation function, as shown below:

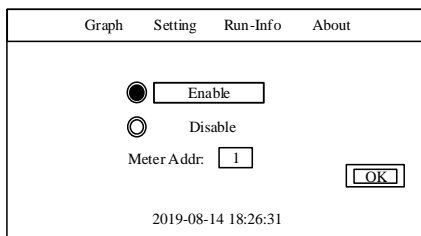

Figure 6.39 Export Limitation Setup

Select “Setting” in menu, press ENT button to pull out the second menu, select “Battery Setting” and press ENT button to enter battery parameter setup interface, as shown below:

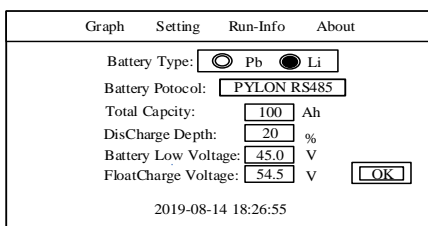

Figure 6.40 Interface of Battery parameter setup

Select “Setting” in menu, press ENT button to pull out the second menu, select “System Setting” and press ENT button to enter system parameter setup interface, as shown below:

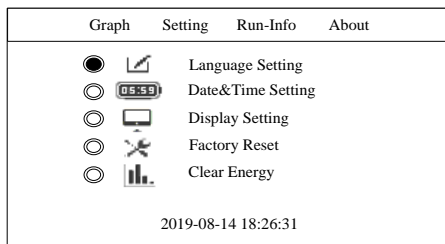

Figure 6.41 Interface of system parameter setup

In the interface of system parameter setup, press ▼ or ▲ to select corresponding parameter, for example the option of “Language Setting”.

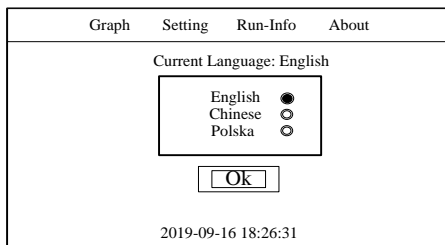

Figure 6.42 System language setup

E.g. select option of “Date&Time Setting”.

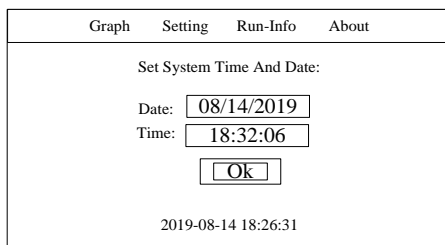

Figure 6.43 System date and time setup

E.g. select option of “Display Setting”

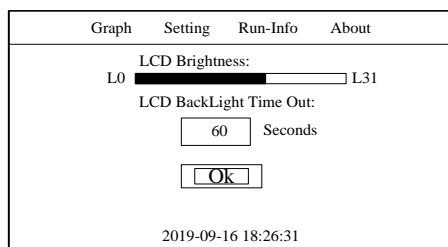

Figure 6.44 Parameter of display setup

E.g. select option of “Factory Setting” The default password is:123456.



Figure 6.45 Factory setting

E.g. select option of “Clear Energy”

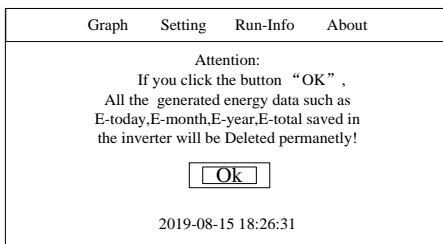

Figure 6.46Clear Energy

E.g. select option of “Clear Error Records”

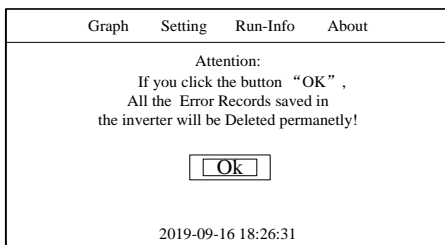

Figure 6.47 Clear Error Records

E.g. select option of “Grid Compliance”

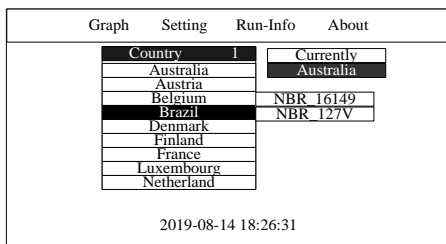

Figure 6.48 Grid Compliance setup

E.g. select option of “Communication Set”

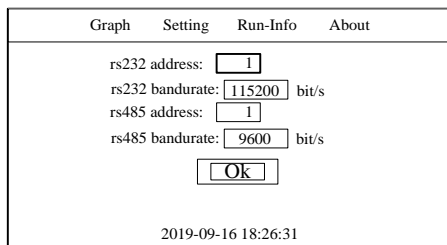

Figure 6.49 Communication Set

E.g. select option of “Change Password”

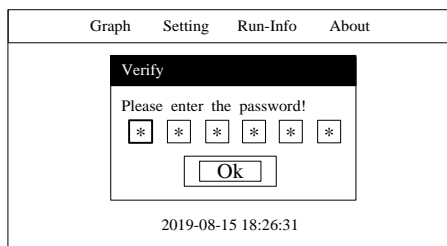

Figure 6.50 Change Password

To change system password, enter the interface of changing system password, input a new password, then the general admin's password can be changed. System super admin's password is "658513", this cannot be changed.

E.g. select option of "Beep&Led Setting".

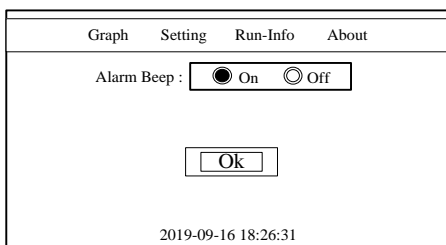

Figure 6.51 Setup of Beep and Led

While error occurring or warning in system, LCD will appear prompt box to show the information about the error or warning. As shown below:

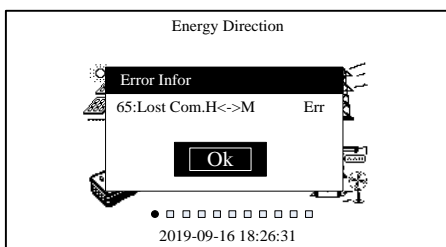

Figure 6.52 Interface of warning

While error occurring or warning, LCD will display the prompt box as shown above, if system has error alarm, the prompt box will appear and system beep will work, the status light will turn red.

The prompt interface of input password, as shown below:

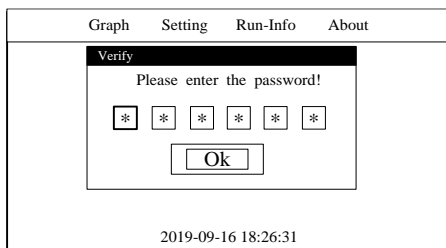

Figure 6.53 The prompt interface of input password

In the interface of password input, press ▼ or ▲ to edit the password. ENT button for entering edit status, press ▼ or ▲ again to input the password. ESC button for exiting edit status, select “OK” to enter next interface.

ENT button pressing time longer than 2 second, LCD will show a prompt box of input load, press ENT to confirm, inverter begins to enter loading status. As shown below:

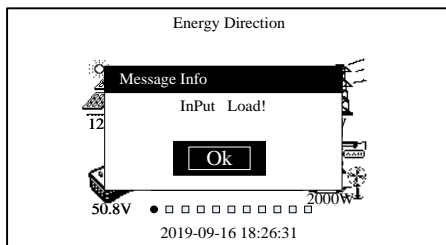

Figure 6.54 Prompt of input load

1

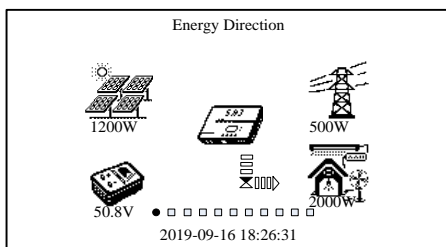

Figure 6.55 Process of input load

ESC button pressing time longer than 2 second, LCD will show a prompt box of cutoff load, press ENT to confirm, inverter begins to cutoff load. As shown below:

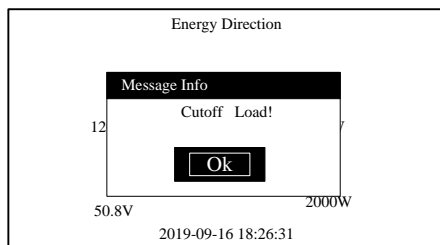

Figure 6.56 Process of cutoff load

6.3 Shut Down Inverter

The H1 inverter can be shut down by the following procedure:

1. Turn off the external AC switch (grid side)
2. Turn off the DC switch on the inverter
3. Turn off the battery switch between inverter and battery

6.4 Monitoring Operation and Battery manage system

The equipment is equipped with a RS232 interface, RS232 can connect with Wi-Fi module, which can be used in monitoring of the operation status.

By connecting the internet through a Wi-Fi module and uploading the data of the inverter to server, users can monitor the operational information of the inverter by web version web portal or mobile APP (please download the mobile APP from APP store) remotely.

The equipment is equipped with a RS485 interface, RS485 can be connected to battery manage system, while battery parameter of inverter match with the communication protocol of battery manage system, inverter would obtain the data.

Chapter 7 Fault Code and Troubleshooting

Code	Fault Information	Explanation	Fault type
Master Device Error			
01	Relay Err	Relay Error	Error
02	GFCI Device Err	GFCI Devices Error	Error
03	Fan Err	Fan Error	Error
04	Eeprom Err	Storer Error	Error
05	Lost Com.M<->S Err	Interior Communication	Error
06	ISO Err	Insulation Error	Error
07	Temp.High Err	High Temperature	Error
08	Temp.Low Err	Low Temperature	Error
09	Bus Volt.High Err	Over Bus Voltage	Error
10	Bus Volt.Low Err	Under Bus Voltage	Error
11	GFCI Err	GFCI Error	Error
12	DCI Err	DCI Devices Error	Error
13	HWBus Volt.High Err	Bus Hardware Over-voltage	Error
14	HWPV1 Curr.High Err	PV1 Hardware Over-current	Error
15	HWPV2 Curr.High Err	PV2 Hardware Over-current	Error
16	HWInv Curr.High Err	Inverter Hardware Over-current	Error
17	Inv Short Err	Inverter short circuit error	Error
18	Over Load Err	Output overload error	Error
19	PV1 Volt.High Err	PV1 Over-voltage	Error
20	PV2 Volt.High Err	PV2 Over-voltage	Error
21	PV1 Curr.High Err	PV1 Over-current	Error
22	PV2 Curr.High Err	PV2 Over-current	Error
23	Inv Curr.High Err	Inverter Over-current	Error
24	Reserved (bit 24) Err	Reserved (bit 24)	Error
25	Grid Volt.High Warn	Voltage of Grid High	Alarm
26	Grid Volt.Low Warn	Voltage of Grid Low	Alarm
27	Grid Freq.High Warn	Frequency of Grid High	Alarm
28	Grid Freq.Low Warn	Frequency of Grid Low	Alarm

29	Grid Loss Warn	Grid Lost	Alarm
30	Grid Volt.10min Warn	Average voltage of 10 minutes	Alarm
31	Over Load Warn	Over-load	Alarm
32	Out Volt. Low Warn	Output under-voltage	Alarm
Slave Device Error			
33	Bat Input Short Err	Battery input short circuit	Error
34	Bat Volt.High Err	Battery over-voltage	Error
35	Fan Err	Fan erroe	Error
36	Bus SoftTimeOut Err	Bus soft start time out	Error
37	Lost Com.M<->S Err	Lost interior communication	Error
38	Reserved (bit 38) Err	Reserved (bit 38)	Error
39	Bus Volt.High Err	Over Bus Voltage	Error
40	Reserved (bit 40) Err	Reserved (bit 40)	Error
41	Bus Volt.Consis Err	Data Consistency of Bus Voltage Error	Error
42	Out Insert Err	Output Connection error	Error
43	Inv Wave Err	Inverter voltage wave error	Error
44	GFCI Consis Err	Data Consistency of GFCI Error	Error
45	Reserved (bit 45) Err	Reserved (bit 45)	Error
46	DVI Consis Err	Data Consistency of DVI	Error
47	CHG1 Curr Err	Charging bridge 1 current error	Error
48	CHG2 Curr Err	Charging bridge 2 current error	Error
49	Grid Volt.Consis Warn	Data Consistency of Grid Voltage Error	Alarm
50	Grid Freq.Consis Warn	Data Consistency of Grid Frequency	Alarm
51	Bms Com Lost Warn	BMS Communication Lost	Alarm
52	GND loss Warn	Ground lost	Alarm
53	LN Wrong Warn	L and N Wires Connected Reverseely	Alarm
54	ForbidCharge Warn	Battery Forbidden Charge	Alarm
55	forbidDisCharge Warn	Battery Forbidden Discharge	Alarm
56	ForceCharge Warn	Battery Forced Charge	Alarm
57	Grid Volt.High Warn	Voltage of Grid High	Alarm

58	Grid Volt.Low Warn	Voltage of Grid Low	Alarm
59	Grid Freq.High Warn	Frequency of Grid High	Alarm
60	Grid Freq.Low Warn	Frequency of Grid Low	Alarm
61	Grid Loss Warn	Grid Loss	Alarm
62	Battery Open Warn	Battery open circuit	Alarm
63	Battery Dod Warn	Battery Discharge End	Alarm
64	Battery Low Warn	Battery under-voltage	Alarm
Display Board Error			
65	Lost Com.H<->M Err	Display board communication lost	Error
66	HMI Eeprom Err	Eeprom Error	Error
67	HMI RTC Err	RTC error	Error
68	BMS Device Err	BMS Device Error	Error
81	BMS Cell Volt.H Warn	BMS cell voltage high warning	Alarm
82	BMS Cell Volt.L Warn	BMS cell voltage low warning	Alarm
83	BMS CHG Curr.H Warn	BMS charging current high warning	Alarm
85	BMS DCHG Curr.H Warn	BMS discharging current high warning	Alarm
86	BMS DCHG TempH Warn	BMS discharging temperature high warning	Alarm
87	BMS CHG TempH Warn	BMS charging temperature high warning	Alarm
88	BMS Voltage Low Warn	BMS voltage low warning	Alarm
89	BMS Lost.Conn Warn	BMS communication lost warning	Alarm
91	Meter Lost Com Warn	Meter Lost Communication Warning	Alarm
92	DRM0 Warn	DRM0 Warn	Alarm

Chapter 8 Recycling and Disposal

This device should not be disposed as residential waste. An Inverter that has reached the end of its life and is not required to be returned to your dealer, it must be disposed carefully by an approved collection and recycling facility in your area.

Chapter 9 Contact SAJ

Guangzhou Sanjing Electric Co., Ltd.

SAJ Innovation Park, No.9, Lizhishan Road, Guangzhou Science City, Guangdong, P.R.China.

Postcode: 510663

Web: <http://www.saj-electric.com>

Technical Support & Service

Tel: +86 20 6660 8588

Fax: +86 20 6660 8589

E-mail: service@saj-electric.com

International Sales

Tel: 86-20-66608618/66608619/66608588/66600086

Fax: 020-66608589

E-mail: info@saj-electric.com

Domestic Sales

Tel: 020-66600058/66608588

Fax: 020-66608589

Warranty Card

The installer should fill in the second form while installing the inverter. For warranty claim, please complete the below forms and send this page to SAJ attached with the Customer's invoice.

For Customer to fill in

Name:		
City:	Country:	Zip:
Tel:	Fax:	E-mail:

Information on Device

Device type:	Serial No.(S/N):
Invoice No:	Commissioning date:
Fault time:	
Error message (Display reading):	
Brief fault description & photo:	
Signature: _____ Date: _____	

For Installer to fill in

Modules Used:		
Modules Per String:	No. of String:	
Installation Company:	Contractor License Number:	
Company:		
City:	Country:	Zip:
Tel:	Fax:	E-mail:
Signature: _____ Date: _____		



Guangzhou Sanjing Electric CO., LTD.

ADD: SAJ Innovation Park, No.9, Lizhishan Road, Science City,
Guangzhou High-tech Zone, Guangdong, P.R.China

Zip: 510663 Tel: +86 20 6660 8588 Fax: +86 20 6660 8589

Web: <http://www.saj-electric.com>

Edition No. V1.0

* Due to the continuous improvement of products, technical parameters in this manual are modified without prior notice.